













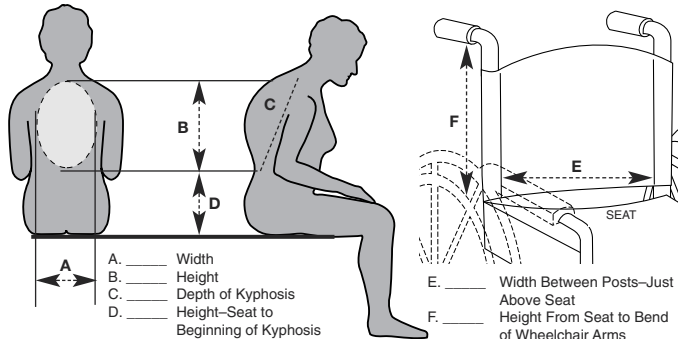





















	CAT. NO	DESCRIPTION	ORDER MINIMUMS	UNIT	SUGG. INST. PRICES																												
	100BW	BackWing Buddy ProFab 2000 and Gray Vinyl Chair Style	1	ea	105.56																												
	100BWC	Wheelchair Style	1	ea	105.56																												
	100KB	KyphoBuddy Custom: Provide measurements A-F Standard: Provide measurement E only	1 1	ea ea	317.74 264.69																												
	100KBS																																
 <p>A. _____ Width B. _____ Height C. _____ Depth of Kyphosis D. _____ Height-Seat to Beginning of Kyphosis E. _____ Width Between Posts-Just Above Seat F. _____ Height From Seat to Bend of Wheelchair Arms</p>			<table border="1"> <thead> <tr> <th>Contact</th> <th>Price</th> <th>Quan.</th> <th>Total</th> </tr> </thead> <tbody> <tr> <td>KyphoBuddy™</td> <td></td> <td></td> <td></td> </tr> <tr> <td>100KBS Standard</td> <td></td> <td></td> <td></td> </tr> <tr> <td>100KB Custom</td> <td></td> <td></td> <td></td> </tr> <tr> <td colspan="2" style="text-align: right;">Subtotal</td> <td></td> <td></td> </tr> <tr> <td colspan="2" style="text-align: right;">Shipping & Handling</td> <td></td> <td></td> </tr> <tr> <td colspan="2" style="text-align: right;">TOTAL</td> <td></td> <td></td> </tr> </tbody> </table>			Contact	Price	Quan.	Total	KyphoBuddy™				100KBS Standard				100KB Custom				Subtotal				Shipping & Handling				TOTAL			
Contact	Price	Quan.	Total																														
KyphoBuddy™																																	
100KBS Standard																																	
100KB Custom																																	
Subtotal																																	
Shipping & Handling																																	
TOTAL																																	
	100R	ReclineBuddy	1 3 6	ea ea ea	211.65 152.07 144.48																												
	396 398	Wheelchair BackBuddy TemPro - Conforms to body heat and pressure Deluxe - ProFoam	1 3 1 3	ea ea ea ea	105.56 105.56 94.95 94.95																												
	103	Torch-Eze Pillow Portable comfortable cushion	1	ea	74.21																												

	CAT. NO	DESCRIPTION	ORDER MINIMUMS	UNIT	SUGG. INST. PRICES
	289-181	Original FootBuddy 1" Thick	1	ea	95.43
	289-182	2" Thick	1	ea	95.43
	289-183	3" Thick	1	ea	106.04
	289-184	4" Thick	1	ea	116.65
	389-181	FootBuddyII 1" Thick	1	ea	95.43
	389-182	2" Thick	1	ea	106.04
	389-183	3" Thick	1	ea	106.04
	389-184	4" Thick	1	ea	116.65
	290-180	Original LegBuddy	1	ea	42.38
	390-180	LegBuddyII	1	ea	42.38
	489SW-181	FootBuddyIII for Contracture Standard	1	ea	211.65
	489SWX	Custom	1	ea	Call for Price
	300-2	Recliner FootBuddy 2" Thick Cushion	1	ea	200.51
	300-3	3" Thick Cushion	1	ea	211.65
	USPC-16	ProContourBuddy 16"	1	ea	84.82
	USPC-18	18"	1	ea	84.82
	USPC-20	20"	1	ea	95.43
	USALB	US ActivlapBuddy[®]	1	ea	95.43
	USLB	US LapBuddy[®]	1	ea	52.99
	USCB	US ChairBuddy	1	pair	95.43
	100WB	WalkerBuddy	1	pair	42.38

	CAT. NO	DESCRIPTION	ORDER MINIMUMS	UNIT	SUGG. INST. PRICES
	110ACT	ACTIVBUDDIES ActivCushion for Overchair/Overbed Table	1 3 6	ea ea ea	84.82 79.51 74.21
	184ACT	ActivLap Pillow	1 3 6	ea ea ea	74.21 74.21 68.91
	189ACT	ActivLapBuddy®	1 3 6	ea ea ea	84.82 79.51 74.21
	189DACT	ActivLapBuddy® - Deskarm Wheelchair	1 3 6	ea ea ea	84.82 79.51 74.21
	1880ACT	ActivLapTray Buddy	1 3 6	ea ea ea	106.04 100.73 95.43
	110BZ	BUSYBUDDIES BusyCushion for Overchair/Overbed Table	1 3	ea ea	74.21 63.60
	184BZ	BusyLapPillow	1 3	ea ea	74.21 63.60
	189BZ	BusyBuddy	1	ea	84.82
	189DABZ	BusyBuddy - Deskarm Wheelchair	1	ea	84.82
	1880BZ	BusyLapTray Buddy	1 3	ea ea	100.73 95.43
	189PK	BusyBuddy Activity Pack	1	ea	84.82

	CAT. NO	DESCRIPTION	ORDER MINIMUMS	UNIT	SUGG. INST. PRICES
	189	LAPBUDDIES[®] LapBuddy [®]	1 3 6	ea ea ea	52.99 50.87 48.75
	189DA	DeskArm LapBuddy [®]	1 3 6	ea ea ea	52.99 50.87 47.69
	189EZ	EZ - Open LapBuddy [®]	1 3 6	ea ea ea	74.21 72.09 68.91
	189DAEZ	EZ - Open DeskArm LapBuddy [®]	1 3 6	ea ea ea	74.21 72.09 68.91
	1880	LapTray Buddy	1 3 6	ea ea ea	95.43 74.21 68.91
	100CB	LATERAL SUPPORT CUSHIONS ChairBuddy For Reclining Chairs	1	pr	84.82
	100CBW	For Wheelchairs with Velcro Straps	1	ea	42.38
	100WC	WheelchairBuddy	1	pr	73.20
	100KA	KneeAbductorBuddy Custom: Provide measurements 1 & 2	1	ea	158.60
	100KAS	Standard 10" x 10" overall; Measurement 1 = 3" Measurement 2 = 90 degrees	1	ea	105.56

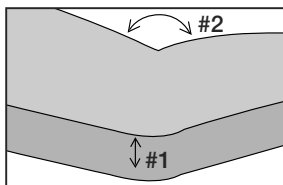



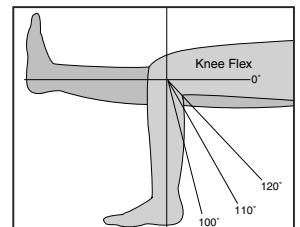
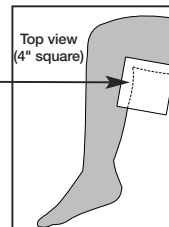
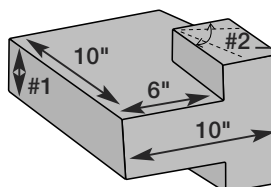









Order Form
100KA Custom
KneeAbductorBuddy™















#1 Measure distance between knees to align hips at neutral= _____ inches
(features parallel)

#2 Measure degrees of knee extension: _____°.

	CAT. NO	DESCRIPTION	ORDER MINIMUMS	UNIT	SUGG. INST. PRICES	
	285P-13	ArmCradleBuddy Polyester, 13" height	1	ea	95.43	
	285P-14	Polyester, 14" height	1	ea	95.43	
	285S-14	Faux Sheepskin, 14" height	1	ea	95.43	
	286LP	Elevated ArmCradleBuddy Polyester, Left	1	ea	95.43	
	286LS	Faux Sheepskin, Left	1	ea	95.43	
	286RP	Polyester, Right	1	ea	95.43	
	286RS	Faux Sheepskin, Right	1	ea	95.43	
	294-411	ArmBuddy 11" Long, 4" Diameter	1	ea	41.38	
	294-416	16" Long, 4" Diameter	2	ea	40.31	
	294-511	11" Long, 5" Diameter	1	ea	47.74	
	294-516	16" Long, 5" Diameter	2	ea	46.68	
	294-611	11" Long, 6" Diameter	1	ea	42.44	
	294-616	16" Long, 6" Diameter	2	ea	41.38	
	294-711	11" Long, 7" Diameter	1	ea	49.86	
	294-716	16" Long, 7" Diameter	2	ea	48.80	
				1	ea	49.86
				2	ea	47.74
	294F-411	FlatArmBuddy 11" Long, 4" Diameter	1	ea	46.68	
	294F-416	16" Long, 4" Diameter	2	ea	45.62	
	294F-511	11" Long, 5" Diameter	1	ea	47.74	
	294F-516	16" Long, 5" Diameter	2	ea	46.68	
	294F-611	11" Long, 6" Diameter	1	ea	46.68	
	294F-616	16" Long, 6" Diameter	2	ea	46.68	
	294F-711	11" Long, 7" Diameter	1	ea	47.74	
	294F-716	16" Long, 7" Diameter	2	ea	46.68	
				1	ea	48.80
				2	ea	47.74
	100DS-16	SEAT CUSHIONS DropSeatBuddy ProFoam 16" Wheelchair	1	st	73.20	
	100DS-18	18" Wheelchair	1	st	78.51	
	100DS-20	20" Wheelchair	1	st	83.81	
	100DSB-16	TemProFoam 16" Wheelchair	1	st	73.20	
	100DSB-18	18" Wheelchair	1	st	78.51	
	100DSB-20	20" Wheelchair	1	st	83.81	
	200DS-16	Solid Seat Insert DropSeatBuddy 2" thick; 16" Wheelchair (14"W x 16"L)	1	ea	158.07	
	200DS-18	2" thick; 18" Wheelchair (16"W x 16"L)	1	ea	158.07	
	200DS-20	2" thick; 20" Wheelchair (18"W x 16"L)	1	ea	168.68	
	300DS-16	3" thick; 16" Wheelchair (14"W x 16"L)	1	ea	168.68	
	300DS-18	3" thick; 18" Wheelchair (16"W x 16"L)	1	ea	168.68	
	300DS-20	3" thick; 20" Wheelchair (18"W x 16"L)	1	ea	179.29	
	DSP	Options for SSI DropSeatBuddy Pommel	1	ea	21.16	
	DSW	Wedge	1	ea	31.77	
	DSWP	Wedge & Pommel	1	ea	42.38	

	CAT. NO	DESCRIPTION	ORDER MINIMUMS	UNIT	SUGG. INST. PRICES
	258PX	Wheelchair Cushion Pyramid - X, 3" thick	1	ea	52.99
	259PX	Pyramid - X, 4" thick	1	ea	63.60
	260PP	ProPeak, 3" thick	1	ea	42.38
	261PP	ProPeak, 4" thick	1	ea	42.38
	394	SeatBuddy Deluxe	1	ea	52.99
	394W	Deluxe with Wedge	3 1	ea ea	52.99 63.60
	395	TemPro	1	ea	74.21
	395W	TemPro with Wedge	3 1	ea ea	74.21 84.82
		ProContour SeatBuddy ProFoam			
	391-16	16" Wheelchair	1	ea	95.43
	391-16CC	16" Wheelchair with Coccyx Cutout	1	ea	106.04
	391-16W	16" Wheelchair with Wedge	1	ea	106.04
	391-16WCC	16" Wheelchair with Wedge & Coccyx Cutout	1	ea	116.65
	391-18	18" Wheelchair	1	ea	106.04
	391-18CC	18" Wheelchair with Coccyx Cutout	1	ea	116.65
	391-18W	18" Wheelchair with Wedge	1	ea	116.65
	391-18WCC	18" Wheelchair with Wedge & Coccyx Cutout	1	ea	127.25
	391-20	20" Wheelchair	1	ea	116.65
	391-20CC	20" Wheelchair with Coccyx Cutout	1	ea	127.25
	391-20W	20" Wheelchair with Wedge	1	ea	127.25
	391-20WCC	20" Wheelchair with Wedge & Coccyx Cutout	1	ea	127.25
		TemProFoam			
	392-16	16" Wheelchair	1	ea	116.65
	392-16CC	16" Wheelchair with Coccyx Cutout	1	ea	127.25
	392-16W	16" Wheelchair with Wedge	1	ea	127.25
	392-16WCC	16" Wheelchair with Wedge & Coccyx Cutout	1	ea	137.86
	392-18	18" Wheelchair	1	ea	116.65
	392-18CC	18" Wheelchair with Coccyx Cutout	1	ea	127.25
392-18W	18" Wheelchair with Wedge	1	ea	127.25	
392-18WCC	18" Wheelchair with Wedge & Coccyx Cutout	1	ea	137.86	
392-20	20" Wheelchair	1	ea	116.65	
392-20CC	20" Wheelchair with Coccyx Cutout	1	ea	127.25	
392-20W	20" Wheelchair with Wedge	1	ea	127.25	
392-20WCC	20" Wheelchair with Wedge & Coccyx Cutout	1	ea	137.86	
	382-18	Gel Insert	1	ea	\$31.77
	297B	Board Insert	1	ea	\$21.16
	252	BedTopBuddy Pyramid-X, 3" Thick	1	ea	206.88
			3	ea	206.88
	253	Pyramid-X, 4" Thick	1	ea	206.88
			3	ea	206.88
	254	ProPeak, 3" Thick	1	ea	158.07
255	ProPeak, 4" Thick	1	ea	168.68	

	CAT. NO	DESCRIPTION	ORDER MINIMUMS	UNIT	SUGG. INST. PRICES
	BSB33 BSB36 BSB43 BSB46	BedSideBuddy 3"T Pad, 3"H Bumper 3"T Pad, 6"H Bumper 4"T Pad, 3"H Bumper 4"T Pad, 6"H Bumper	1 1 1 1	ea ea ea ea	264.16 264.16 285.38 306.60
	100DB	BagBuddy StaphChek®	1	ea	21.16
	100TB	TubeBuddy StaphChek®	1	ea	31.77
	1910-06	HandBuddy Regular	1	pk	42.38
	1911-06	Cone Shaped	1	pk	42.38
	1912-06	Separated	1	pk	46.68
	6426-06	HandGrip Buddy	1	pk	42.38
	DB6X48R DB6X48Y DB6X52R DB6X52Y DB6X56R DB6X56Y	DoorBuddy 6"W x 48" L, Red 6"W x 48" L, Yellow 6"W x 52" L, Red 6"W x 52" L, Yellow 6"W x 56" L, Red 6"W x 56" L, Yellow	1 1 1 1 1 1	ea ea ea ea ea ea	29.65 29.65 31.77 31.77 31.77 31.77
	ATP	Stop Sign	1	ea	10.56
	186 186A 186B	Pro Black Buddy Comfortable cushions covered in soft durable black fabric	1	ea.	42.38 47.74 33.03
	186KA 186KB 186KC	KeyBoard Cushion 3/4" thick 1" thick 1 1/2" thick	1 1 1	ea ea ea	31.77 31.77 31.77
	186FA	FootRest	1	ea	31.77
	189V	LapCushion	1	ea	63.60