



Stretcher/Gurney Pads

All Makes And Models

CONDUCTIVE*



HAUSTED®

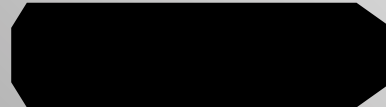

STRYKER®



STERIS®



SHAMPAINE®

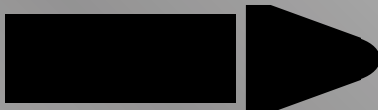

RELIANCE®

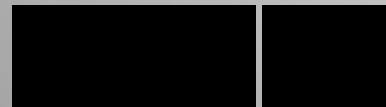

GENDRON®

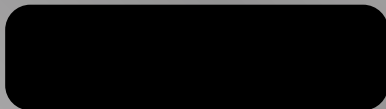

COLSON®



FERNO WASHINGTON®



LISTED
CONDUCTIVE

Angio/Cardiac Pads

All Makes & Models



G.E.® ANGIO



PHILLIPS® ANGIO

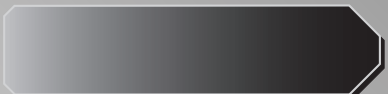

STRYKER®



TOSHIBA® CAT

CT/Table Pads



PHILLIPS® CX



PICKER® CT



SIEMENS® SOMATOM PLUS

AND ALL OTHER MAKES & MODELS!

Whatever Size, Shape, Style or Color Profex is your best Source for Pads, Positioner, & Straps, Profex makes it fast, easy and economical. Order Now and Save.

NON-CONDUCTIVE

101X-1	1" Thick	\$211.65
101X-2	2" Thick	\$264.16
101X-3	3" Thick	\$296.95
101X-4	4" Thick	\$306.60

CONDUCTIVE

101XX-1	1" Thick	\$222.26
101XX-2	2" Thick	\$274.77
101XX-3	3" Thick	\$306.60
101XX-4	4" Thick	\$317.21

Custom is Standard at Profex

Call 800-325-0196



OR Table Pads



**LISTED
CONDUCTIVE**

Upgrade Now for JCAH Survey

ReNew OR Tables with
New Unexcelled Profex® Pads



AMSCO/STERIS® #2080



AMSCO/STERIS® #3080



AFFILIATED® #600



SKYTRON® #5000/6000



SHAMPAINÉ® #1400/1500/1600



AND ALL OTHER MAKES & MODELS!

Whatever Size, Shape, Style or Color Profex is your best Source for Pads, Positioner, & Straps, Profex makes it fast, easy and economical. Order Now and Save.

NON-CONDUCTIVE

111C	2" Thick	\$370.25
111D	2½" Thick	\$465.74
111E	3" Thick	\$497.56
111F	4" Thick	\$518.78

CONDUCTIVE

111CC	2" Thick	\$402.08
111DD	2½" Thick	\$472.10
111EE	3" Thick	\$519.84
111FF	4" Thick	\$625.93



Pads & Positioners

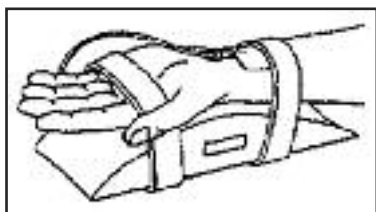

ARTERIAL CANNULATION POSITIONER (ACP)
Used by Anesthesiologists to position the arm for quick and accurate A-line insertions. (12 per case)

175 1 cs **\$95.43**



PILLOW KEEP
Optional Department Name Printed on Pillow
ER, OR, ICU, etc.

100PK 1ea **\$95.43**



REUSABLE-COVERED POSITIONING PADS, ROLLS, WEDGES, DONUTS, HEAD CRADLES, HEADRESTS.
Made of high quality foam with Listed Conductive covers. Easily cleaned. Large selection of standard sizes and styles. Custom Sizes also available.

Wedge	185A	5"H x 7"D x 17"W	\$51.98 ea.
Headrest	187LA	Small-A=11", B=9" C=2½", D=5", E=5" F=2"	\$100.79 ea.
Donut	196A	7" O.D. x 3" I.D. x 1½" Thick	\$40.17 ea.
Donut	196BB	9" O.D. x 4" I.D. x 2" Thick	\$40.17 ea.
Roll	197AA	6" Dia. x 10" Long	\$40.17 ea.
Roll	197A	6" Dia. x 20" Long	\$50.47 ea.



DONUT WEDGE POSITIONER
15" x 22"L x 2"H

188 **\$106.04 ea.**



ARTHROSCOPIC, WELL LEG POSITIONERS

Position patient's well (non-operative) leg comfortably, promoting circulation. Protects patient's thigh from tourniquets and hold-down bar. One size fits all; easy to use-no ties or adjustments. Dimensions: 26" x 9.63" x 5"

176	Reusable/Non-conductive	\$212.13 ea.
176A	Reusable/Conductive	\$212.13 ea.
176A-1	Disposable Foam Only	\$106.04 ea.



WINGED KNEE CRUTCH CUSHION









#191A	Conductive 16" x 12"	\$212.13 pr.
#191	Non-Conductive 16" x 12"	\$212.13 pr.

WINGED HEEL CUSHION





#191AH	Conductive 10" x 4½"	\$159.08 pr.
#191H	Non-Conductive 10" x 4½"	\$159.08 pr.



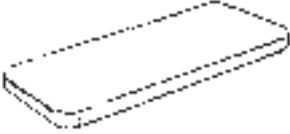

For Custom-Sizes, call or fax us for Order Form #M191.





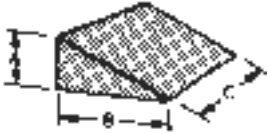

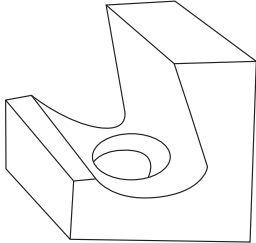
	CAT. NO.	DESCRIPTION	ORDER MIN	UNIT	SUGG. HOSP. PRICE	
		REVOLVING STOOL CUSHIONS NON-CONDUCTIVE				
	141N	12" (30.5 cm) Diameter	1 12	ea ea	47.74 42.38	
	142N	13" (33.0 cm) Diameter	1 12	ea ea	51.98 43.50	
	143N	14" (35.6 cm) Diameter	1 12	ea ea	52.99 50.87	
	144N	15" (38.1 cm) Diameter	1 12	ea ea	58.35 56.23	
	145N	16" (40.6 cm) Diameter	1 12	ea ea	64.71 62.59	
		CONDUCTIVE				
	141C	12" (30.5 cm) Diameter	1 12	ea ea	51.98 49.86	
	142C	13" (33.0 cm) Diameter	1 12	ea ea	55.17 51.98	
	143C	14" (35.6 cm) Diameter	1 12	ea ea	58.35 56.23	
	144C	15" (38.1 cm) Diameter	1 12	ea ea	62.59 60.47	
	145C	16" (40.6 cm) Diameter	1 12	ea ea	62.59 60.47	
		100C	SPECIAL FEATURES FOR CUSHIONS OR COVERS Cut-outs for I.V. Rods or Side Rails	1	ea	10.61
		100NS	P137 Non-Slip Sheeting on bottom of cushion			Call
	100RS	Retaining Straps	1	ea	30.77	
	100SB	Snap-Buttons on bottom of cushion	1	ea	30.77	
	100SH	Snap-Button Hinges for sectional cushions	1	ea	21.22	
	100VH	Velcro Hinge for sectional cushions	1	ea	21.22	
	100VS	Velcro Attachment Strips	1	ea	21.22	
	1750	Cushion Attachment Kit Contains: <ul style="list-style-type: none"> • Pressure Sensitive Velcro Hook and Pile • One 12" (30.5cm) strip x 2" (5.1"cm) wide • Three 8" (20.3 cm) strips x 2" (5.1 cm) wide 	1	ea	62.59	

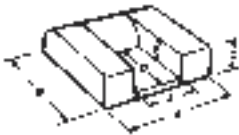
CUSHIONS, PADS AND COVERS

	CAT. NO.	DESCRIPTION	ORDER MIN.	UNIT	SUGG. HOSP. PRICE
		BASSINET PADS with zipper			
	173A	24" x 12 ¹ / ₂ " x 1 ¹ / ₂ " (61.0 cm x 31.8 cm x 3.8 cm) Maroon Sheeting Cover	1	ea	73.20
	173B	24" x 12 ¹ / ₂ " x 2" (61.0 cm x 31.8 cm x 5.1 cm) Maroon Sheeting Cover	1	ea	75.32
	173E	27" x 13" x 2" (68.6 cm x 33.0 cm x 5.1 cm) Maroon Sheeting Cover	1	ea	79.57
	173EE	28" x 16" x 2" (71.1 cm x 40.6 cm x 5.1 cm) Maroon Sheeting Cover	1	ea	94.42
	173X	27" x 13" x 1 ¹ / ₂ " (68.6 cm x 33.0 cm x 3.8 cm) Plastic Film Cover	1	ea	71.08
	173XZ	27" x 13" x 2" (68.6 cm x 33.0 cm x 5.1 cm) Plastic Film Cover	1	ea	73.20
	173IS	ISOLETE/INCUBATOR PADS 24" x 15" x 1 ¹ / ₄ " (60.96 cm x 38.1 cm x 3.71 cm) White Vinyl	1	ea	50.99
	176DP	ARTHROSCOPIC DISPOSABLE INSERT PADS 1 ¹ / ₂ "T x 2 ³ / ₄ " x 38"L—12/cs	1	cs	189.90
	176D-1	3"T x 11 ¹ / ₂ "OD x 7"ID—Deluxe 10/cs	1	cs	211.12
	176S-1	3"T x 11 ¹ / ₂ "OD x 7"ID—Superior 10/cs	1	cs	179.29
	182	FOAM WEDGE PILLOWS NON-CONDUCTIVE Wedge Shape: Tapers from 0" to 2 ¹ / ₂ " (6.4 cm) front to rear, 18" (45.7cm) Wide, 15" (38.1 cm) Deep	1	ea	62.59
	182A	FOAM WEDGE PILLOWS CONDUCTIVE Wedge Shape: Tapers from 0" to 2 ¹ / ₂ " (6.4 cm) front to rear, 18" (45.7cm) Wide, 15" (38.1 cm) Deep	1	ea	73.20
	184	STANDARD NON-FOAM PILLOWS Standard: 15" x 18" x 3" (38.1 cm x 45.7 cm x 7.6 cm)	1	ea	62.59
	184A	STANDARD CONDUCTIVE FOAM PILLOWS Standard: 15" x 18" x 3" (38.1 cm x 45.7cm x 7.6 cm)	1	ea	73.20

	CAT. NO.	DESCRIPTION	ORDER MIN	UNIT	SUGG. HOSP. PRICE
	185	WEDGE SHAPE FOAM PILLOWS Custom-Made, Conductive Specify dimensions	1	ea	Call
	185A	A-5", B-7", C-17", Conductive	1	ea	51.98
	185B	A-8", B-8", C-18", Conductive	1	ea	73.20
	185CSP-1	Wedge Wheelchair Cushion A-4", B-16", C-18" With Grey Twill Cover	1	ea	83.81
	185CSP-2	With Upholstery Grade Vinyl Cover	1	ea	90.18
	185CSP-3	With Water Resistant Staph-Chek Cover	1	ea	92.42
	185M	BED WEDGES A-7½", B-26", C-24" with white cotton removable cover	1	ea	62.59
	185N	A-10½", B-26", C-24" with white cotton removable cover	1	ea	73.20
	185P	A-12½", B-26", C-24" with white cotton removable cover	1	ea	94.42
	187	SURGICAL POSITIONER	1	ea	105.03
	187A	HEAD CRADLES Small—A-6¼", B-7", C-3½"	1	ea	51.98
	187B	Large—A-8", B-9", C-4½"	1	ea	73.20
	187X	Custom-Made (Need A, B & C Dimensions)	1	ea	Call
	187LA	HEAD REST (Extra Firm Foam) Small—A-11", B-9", C-2½", D-5", E-5", F-2"	1	ea	100.79
	187LB	Large—A-13", B-11", C-3½", D-6", E-6", F-3"	1	ea	105.03
	187LX	Custom-Made (Need A, B, C, D, E & F Dimensions)	1	ea	Call

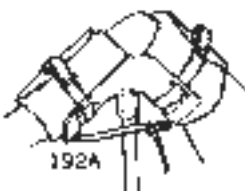
CUSHIONS, PADS AND COVERS

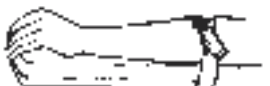
	CAT. NO.	DESCRIPTION	ORDER MIN	UNIT	SUGG. HOSP. PRICE
	190M	KNEE CRUTCH CUSHIONS NON-CONDUCTIVE Standard 15½" x 4" (39.4 cm x 10.2 cm)	1	pr	94.42
	190A	CONDUCTIVE Standard 15½" x 4" (39.4 cm x 10.2 cm)	1	pr	105.03
	191	WINGED KNEE CRUTCH CUSHIONS NON-CONDUCTIVE Standard 14½" x 12" (36.8 cm x 30.5 cm) With Special Velcro Attachment Kit	1	pr	212.13
	191A	CONDUCTIVE Standard 14½" x 12" (36.8 cm x 30.5 cm) With Special Velcro Attachmetn Kit	1	pr	212.13
	191H	WINGED HEEL CUSHION Standard 10" x 4½" (25.4 cm x 11.4 cm) With Velcro NON CONDUCTIVE	1	pr	159.08
	191AH	Standard 10" x 4½" (25.4 cm x 11.4 cm) With Velcro CONDUCTIVE	1	pr	159.08
	192A	KNEE CRUTCH CUSHION CONDUCTIVE BOOT TYPE Calf Section measures 18" x 9" x ½" (45.7 cm x 22.9 cm x 1.3 cm) Thigh Section measures 24" x 7½" x ½" (61.0 cm x 19.1 cm x 1.3 cm)	1	pr	211.12
	193	BODY AND SHOULDER SUPPORT CUSHION NON-CONDUCTIVE 6½" x 3" (16.5 cm x 7.6 cm)	1	pr	93.36
	193A	CONDUCTIVE 6½" x 3" (16.5 cm x 7.6 cm)	1	pr	103.97
	194-1	ARMBOARD PAD CONDUCTIVE 1" Thick Armboard Pad	1	ea	51.98
	194-2	2" Thick Armboard Pad	1	ea	62.59
	194-3	3" Thick Armboard Pad	1	ea	73.20
	194-4	4" Thick Armboard Pad	1	ea	83.81
	194N-1	NON-CONDUCTIVE 1" Thick Armboard Pad	1	ea	41.38
	194N-2	2" Thick Armboard Pad	1	ea	51.98
	194N-3	3" Thick Armboard Pad	1	ea	62.59
	194N-4	4" Thick Armboard Pad	1	ea	73.20
	194SP		1	ea	Call
	195	ARMBOARD STRAP Conductive 24" x 1" (61.0 cm x 2.5 cm)	1	ea	30.77

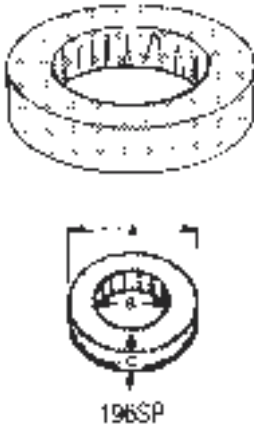
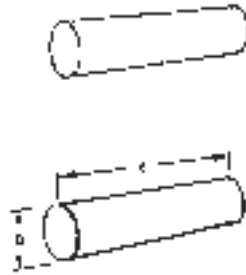
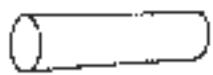
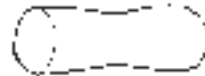
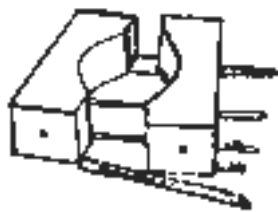
	CAT. NO.	DESCRIPTION	ORDER MIN	UNIT	SUGG. HOSP. PRICE
	196AAA	DONUTS FOR SURGERY — CONDUCTIVE 4" OD x 2" ID x 1 1/2" Thick (10.2 cm x 5.1 cm x 3.8 cm)	1	ea	30.77
	196AA	5 1/2" OD x 2" ID x 2" Thick (14.0 cm x 5.1 cm x 5.1 cm)	1	ea	41.38
	196A	7" OD x 3" ID x 1 1/2" Thick (17.8 cm x 7.6 cm x 3.8 cm)	1	ea	41.38
	196BB	9" OD x 4" ID x 2" Thick (22.9 cm x 10.2 cm x 5.1 cm)	1	ea	41.38
	196B	10" OD x 6" ID x 2" Thick (25.4 cm x 15.2 cm x 5.1 cm)	1	ea	41.38
	196C	11" OD x 5 1/2" ID x 2" Thick (27.9 cm x 14.0 cm x 5.1 cm)	1	ea	47.74
	196SP	Custom Size—Specify dimensions	1	ea	51.98
	197AA	ROLLS FOR SURGERY — CONDUCTIVE 6" Dia. x 10" Long (15.2 cm x 25.4 cm)	1	ea	41.38
	197A	6" Dia. x 20" Long (15.2 cm x 50.8 cm)	1	ea	51.98
	197B	5" Dia. x 17" Long (12.7 cm x 43.2 cm)	1	ea	73.20
	197AXA	*Custom Size up to 8" Dia. x 10" Long (20.3 cm x 25.4 cm)	1	ea	94.42
	197AXB	*Custom Size up to 8" Dia. x over 10" Long up to 24" Long (20.3 cm x 25.4 cm—61.0 cm) *Specify dimensions	1	ea	106.04
	197M	CERVICAL PILLOWS Polyurethane Foam, 20" x 4" with white poly/cotton cover (zippered)	1	ea	30.77
	197S-1	Replacement cover for 197M	1	ea	26.52
	197P	Polyester Fibre Filled, 17" x 7" with white poly/cotton cover (zippered)	1	ea	30.77
	197S-2	Replacement cover for 197P	1	ea	26.52
	199	PRONE POSITION CUSHION set with straps	1	st	158.07



ProfexGel™ Positioning Pads

From Profex...the leading producer of Hospital Cushions for over 60 years... high quality, durable, reusable gel positioning pads... a safe, practical and more economical alternative to disposable foam.

- New Sky Blue Clear Gel
- Pressure Reduction
- Latex Free
- Available covered in UL Listed Conductive material: *New Low Prices*

	G150L	Positioner Large 4.5" x 14" x 2"	95.43 ea
	G151	Stirrup Set w/ Straps Universal Size	200.51 pr
	G152	Hip Pad w/ Post Hole Post Hole is 1.75"	94.42 ea
	G153L	Head Donut 8"OD x 3"ID x 1.75"H	100.79 ea
	G154M	4"W Chest Roll (flat bottom) 4" x 16"L	106.04 ea
	G156M	Knee Crutch Pads 11" x 17" x 1/4"	73.20 ea

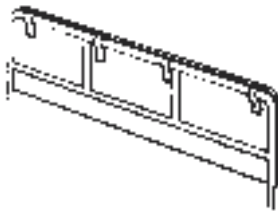
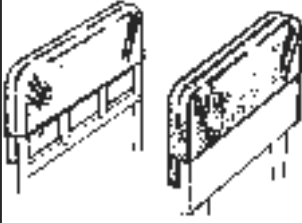
CALL TOLL FREE 1-800-325-0196
FAX 1-901-454-9850

	CAT. NO.	DESCRIPTION	ORDER MIN	UNIT	SUGG. HOSP. PRICE
 <p>Style 1 (Velcro)</p>	BUMPER PADS NON-CONDUCTIVE Vinyl/Nylon Laminated Fabric For Tubular Side Rails with Velcro Fastening Straps				
	BP351-1	15" x 35" x 1" (38.1 cm x 88.9 cm x 2.5 cm)	1	pr	143.97
	BP352-1	15" x 35" x 2" (38.1 cm x 88.9 cm x 5.1 cm)	1	pr	194.41
	BP481-1	15" x 48" x 1" (38.1 cm x 121.9 cm x 2.5 cm)	1	pr	197.91
	BP482-1	15" x 48" x 2" (38.1 cm x 121.9 cm x 5.1 cm)	1	pr	241.02
	BP701-1	15" x 70" x 1" (38.1 cm x 177.8 cm x 2.5 cm)	1	pr	233.70
	BP702-1	15" x 70" x 2" (38.1 cm x 177.8 cm x 5.1 cm)	1	pr	312.79
	For Head and Foot Ends with Velcro Fastening Straps				
	BPHF1-1	15" x 35" x 1" (38.1 cm x 88.9 cm x 2.5 cm)	1	ea	72.10
	BPHF2-1	15" x 35" x 2" (38.1 cm x 88.9 cm x 5.1 cm)	1	ea	97.16
 <p>Style 1 (Envelope Pocket)</p>	For Side Rail with Envelope Pocket				
	BP351-2	15" x 35" x 1" (38.1 cm x 88.9 cm x 2.5 cm)	1	pr	143.97
	BP352-2	15" x 35" x 2" (38.1 cm x 88.9 cm x 5.1 cm)	1	pr	194.41
	BP481-2	15" x 48" x 1" (38.1 cm x 121.9 cm x 2.5 cm)	1	pr	179.97
	BP482-2	15" x 48" x 2" (38.1 cm x 121.9 cm x 5.1 cm)	1	pr	241.02
	BP701-2	15" x 70" x 1" (38.1 cm x 177.8 cm x 2.5 cm)	1	pr	233.70
	BP702-2	15" x 70" x 2" (38.1 cm x 177.8 cm x 5.1 cm)	1	pr	312.79
	For Head and Foot Ends with Envelope Pocket Specify Thickness of Head or Foot Ends				
	BPHF1-2	15" x 35" x 1" (38.1 cm x 88.9 cm x 2.5 cm)	1	ea	72.10
	BPHF2-2	15" x 35" x 2" (38.1 cm x 88.9 cm x 5.1 cm)	1	ea	97.16
	For Solid Head and Foot Ends with Horizontal Fastening Strap				
	BPHF1-3	15" x 35" x 1" (38.1 cm x 88.9 cm x 2.5 cm)	1	ea	72.10
	BPHF2-3	15" x 35" x 2" (38.1 cm x 88.9 cm x 5.1 cm)	1	ea	97.16